

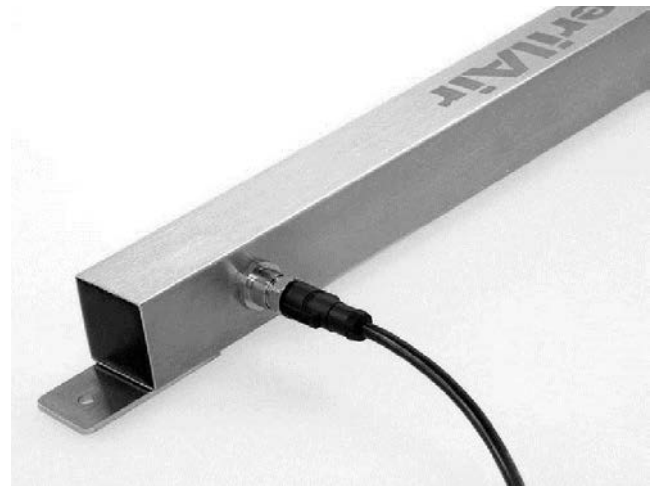

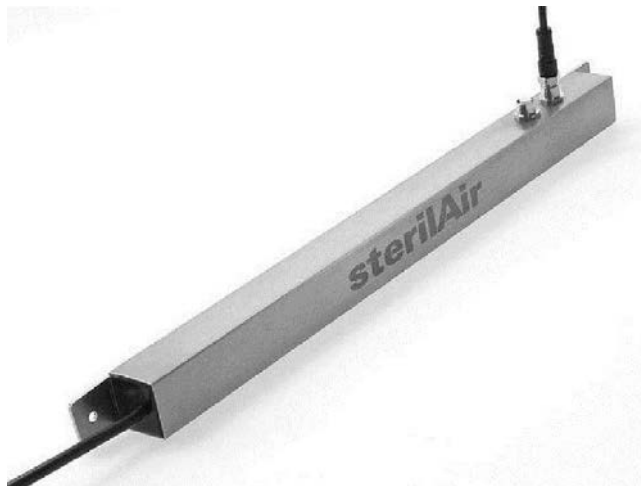



EBM/ EBD

Electrical ballast for sterilAir module



- Fully encapsulated system unit (IP65)
- M12 connector (stainless steel)
- As mono-or double ballast
- CE and EMC
- Mounting on blind rivet nuts or tab
- 10m Power cord

Produktbezeichnung	EBM18	EBD18	EBM36	EBD36	EBM58	EBD58
Power consumption	18 W, 0.08 A	36 W, 0.19 A	41 W, 0.18 A	72 W, 0.34 A	58 W, 0.27 A	116 W, 0.51 A
Supply voltage	230 V _{AC} ±4%	230 V _{AC} ±4%	230 V _{AC} ±4%	230 V _{AC} ±4%	230 V _{AC} ±4%	230 V _{AC} ±4%
Frequency	50..60 Hz	50..60 Hz	50..60 Hz	50..60 Hz	50..60 Hz	50..60 Hz
Ambient temperature	-18°C..+50°C	-18°C..+50°C	-18°C..+50°C	-18°C..+50°C	-18°C..+50°C	-18°C..+50°C
Number of connections	1	2	1	2	1	2
Pinout	5 pole 	5 pole 	5 pole 	5 pole 	5 pole 	5 pole 
M12 tightening torque	0.6 Nm	0.6 Nm	0.6 Nm	0.6 Nm	0.6 Nm	0.6 Nm
UV tube type sterilAir	UVC 2018-xx UVC 2020-xx	UVC 2018-xx UVC 2020-xx	UVC 2030x UVC 2036x	UVC 2030x UVC 2036x	UVC 2036x	UVC 2036x
Material	V2A	V2A	V2A	V2A	V2A	V2A
Max. length connection cord	2.0m	2.0m	2.0m	2.0m	2.0m	2.0m
Classification	CE, EMC	CE, EMC	CE, EMC	CE, EMC	CE, EMC	CE, EMC
IP protection	IP 65	IP 65	IP 65	IP 65	IP 65	IP 65

EBM/ EBD

Electrical ballast for sterilAir module

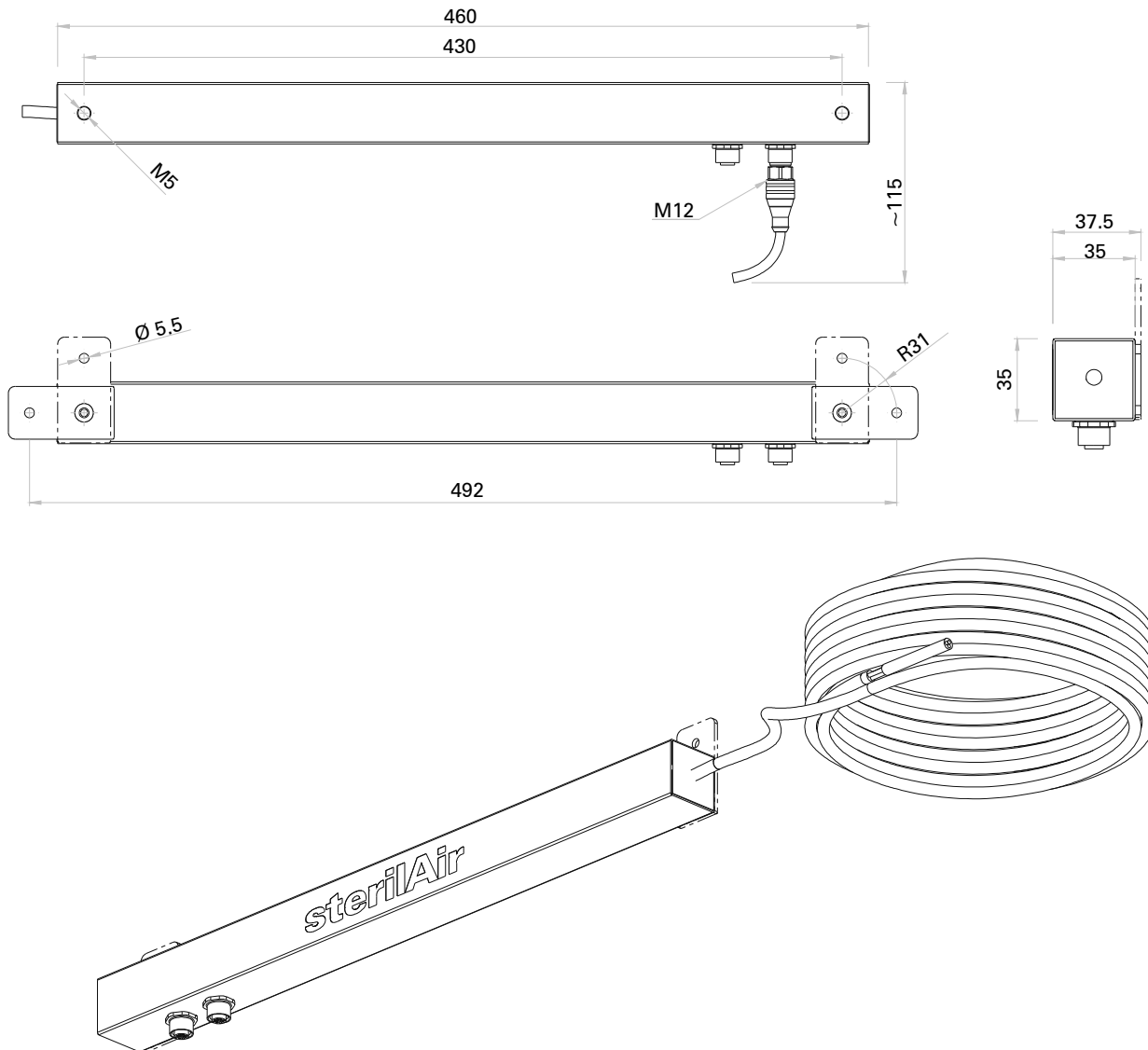

Produktbezeichnung

EBMxx

EBDxx

mounting tab

30 x 60 x 2.5 mm

30 x 60 x 2.5 mm

Weight per unit

1.60 kg

1.61 kg